

BasorTray

NR2E

CATALOGO PRODOTTI

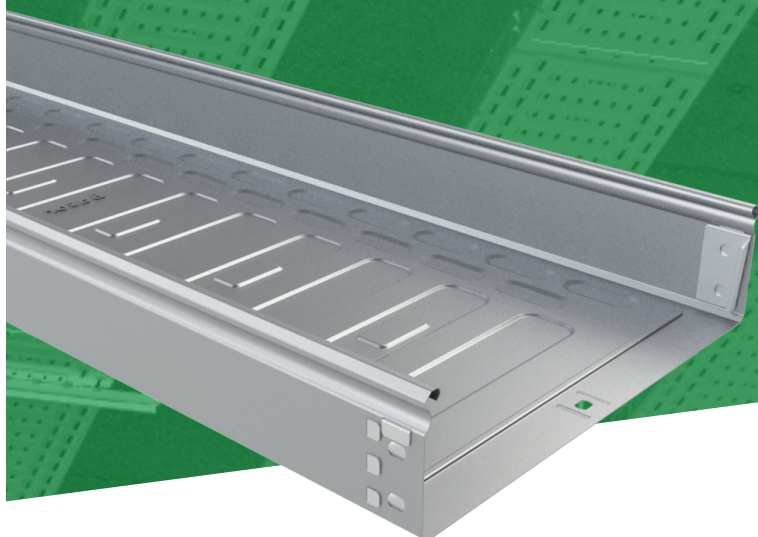
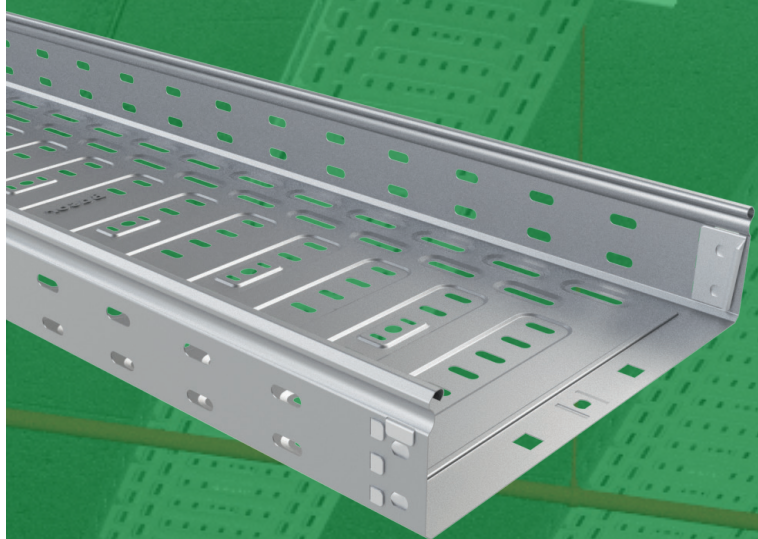

3E Basor
CABLE TRAY SPECIALIST

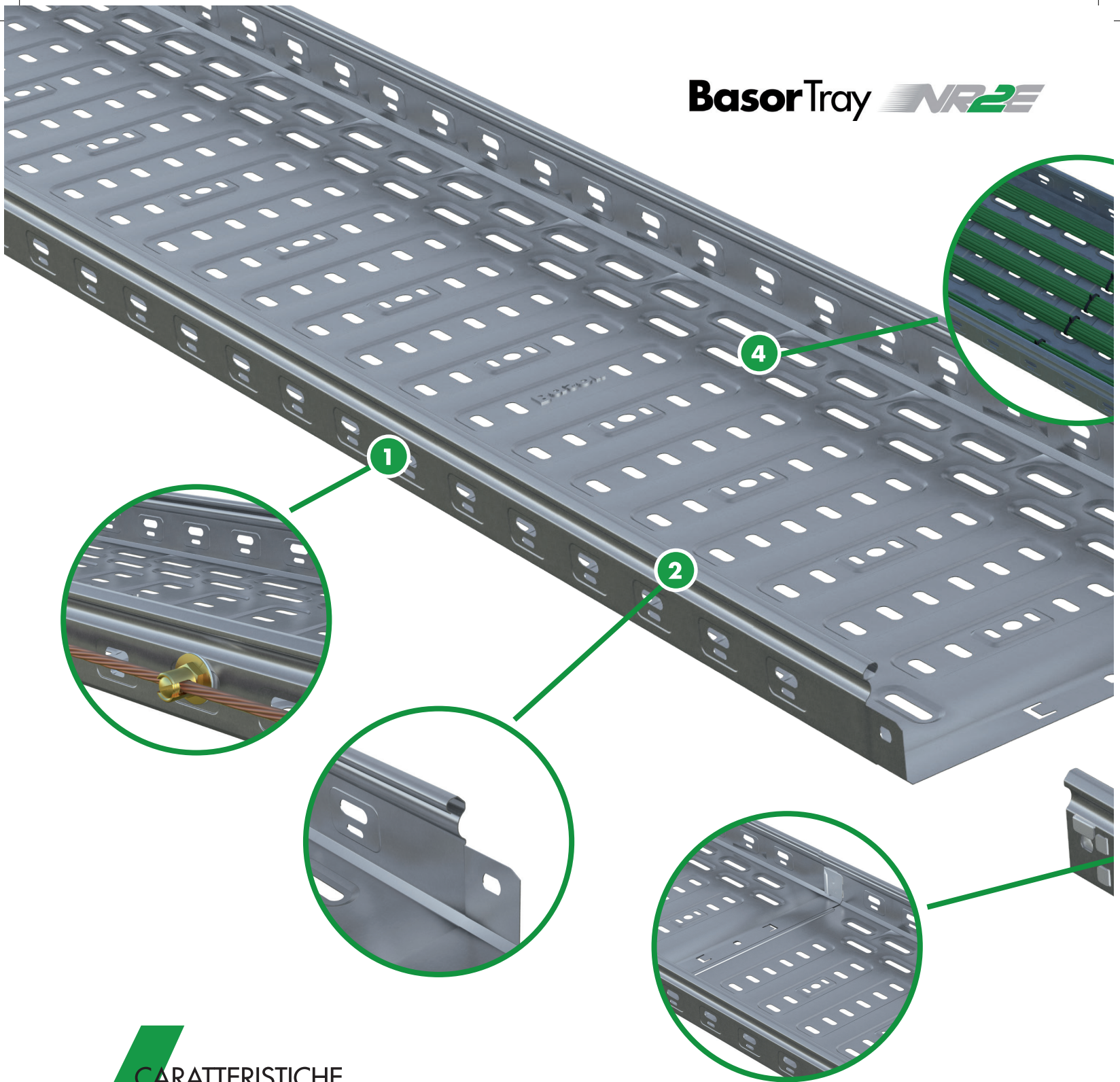

CARATTERISTICHE

- 1 Fori sui fianchi**
Appositamente progettato per fissare il filamento di rame della messa a terra con ponticello o fascetta.
- 2 Bordo di sicurezza**
Bordo arrotondato che permette di non danneggiare i cavi una volta installati.
- 3 Unione salvacavi**
L'unione tra i due canali portacavi è protetto da un margine che salvaguarda i cavi durante i movimenti.
- 4 Fori centrali**
Per poter bloccare i cavi in modo semplice e sicuro.
- 5 Coperchio a pressione**
Grazie al bordo arrotondato, il coperchio si fissa al canale portacavi senza accessori supplementari.
- 6 Sistema di connessione rapida**
Non sono necessarie viti per fissare due canali portacavi.
- 7 Fori per barre filettate**
Posizionati al centro per facilitare l'installazione della barra filettata.
- 8 Versatilità**
Nel caso di tagli, la sua conformazione simmetrica consente di avere sempre un accesso per l'installazione sui supporti.

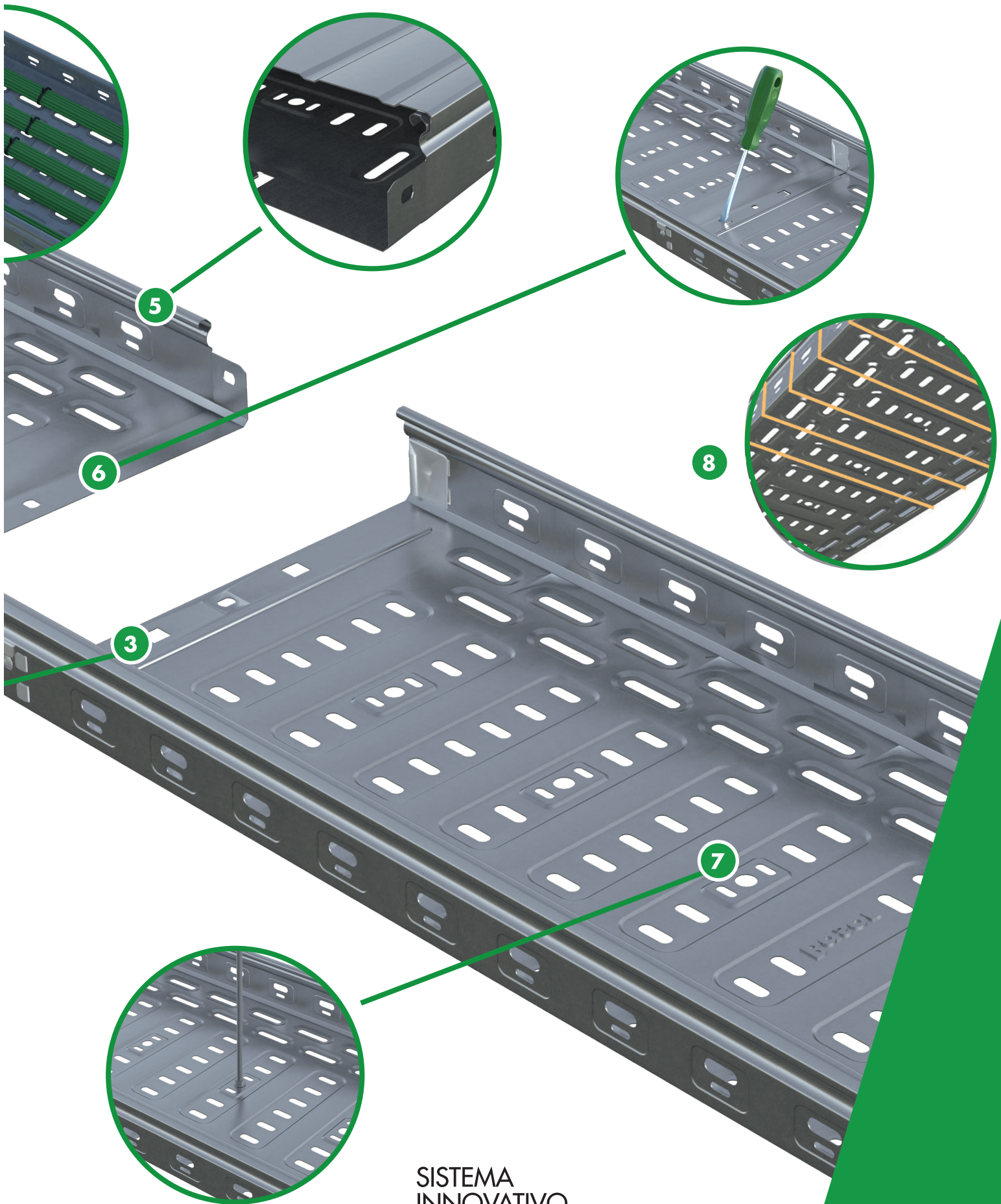

SISTEMA
INNOVATIVO
DI CANALE
PORTACAVI

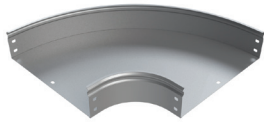
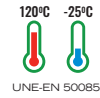
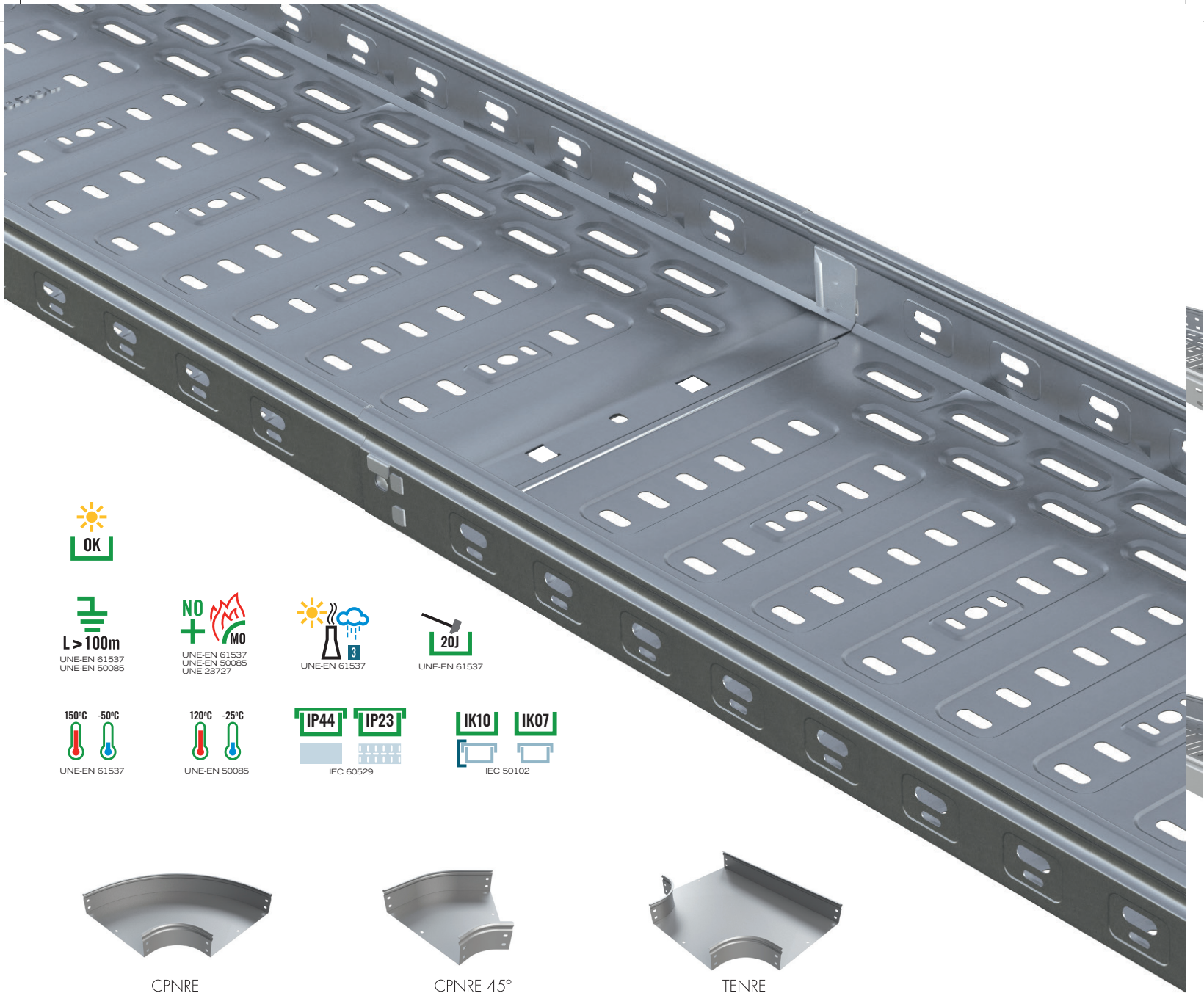

CPNRE

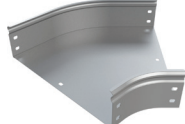

CPNRE 45°

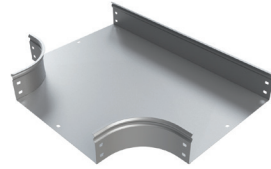

TENRE

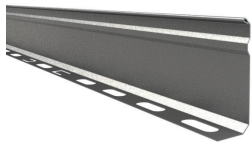

PS

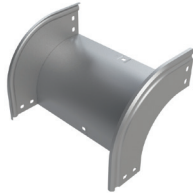

CXNRE

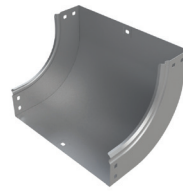

CCNRE

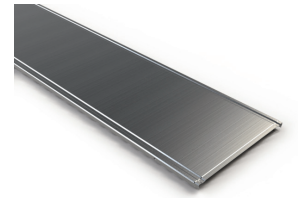

TNR2E

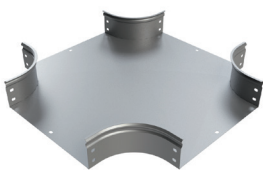

CRNRE

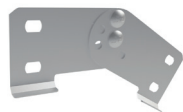

JUNRE-A

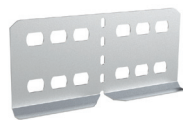

JUNRE-B



JUNRE



JUNRE-C

NRE H75

Larghezza		Capacità volumetrica	
mm	inch	cm ³	in ²
100	4"	71	11,0
150	6"	108	16,7
200	8"	145	22,5
300	12"	220	34,1
400	16"	295	45,7
500	20"	369	57,2
600	24"	444	68,8

NR2E H75

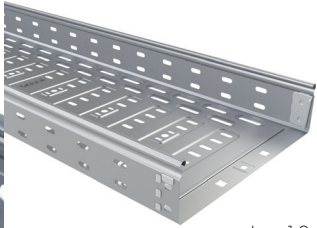

L = 10 FT / 3 m

	larghezza		Zincato Sendzimir
	inch	mm	
NR2E 100X75	4"	100	223995
NR2E 150X75	6"	150	223996
NR2E 200X75	8"	200	223997
NR2E 300X75	12"	300	223998
NR2E 400X75	16"	400	223999
NR2E 500X75	20"	500	224000
NR2E 600X75	24"	600	224001

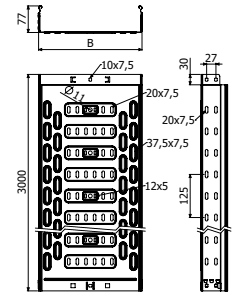

NR2E-C H75



L = 10 FT / 3 m

	larghezza		Zincato Sendzimir
	inch	mm	
NR2E-C 100X75	4"	100	224002
NR2E-C 150X75	6"	150	224003
NR2E-C 200X75	8"	200	224004
NR2E-C 300X75	12"	300	224005
NR2E-C 400X75	16"	400	224006
NR2E-C 500X75	20"	500	224007
NR2E-C 600X75	24"	600	224008



1/100 x B1 (204356 EZ)

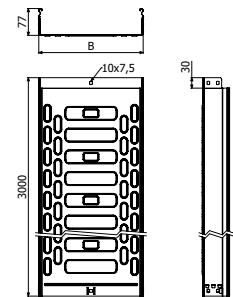

TNR2E

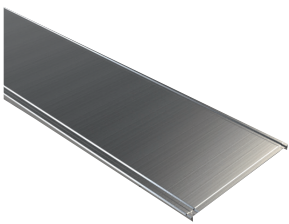

L = 10 FT / 3 m

	larghezza		Zincato Sendzimir
	inch	mm	
TNR2E 100	4"	100	224841
TNR2E 150	6"	150	224842
TNR2E 200	8"	200	224843
TNR2E 300	12"	300	224844
TNR2E 400	16"	400	224845
TNR2E 500	20"	500	224846
TNR2E 600	24"	600	224847

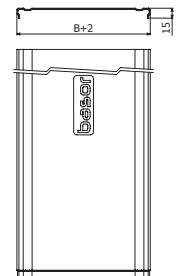

PTNRE



	Acciaio inossidabile
PTNRE 100x75	224850
PTNRE 150-600x75	224851

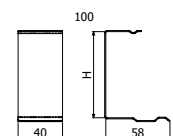
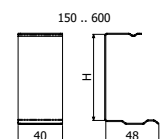

CPNRE 90°

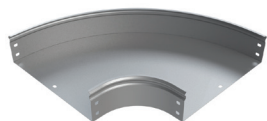

	larghezza		Zincato Sendzimir
	inch	mm	
CPNRE 90° 100X75	4"	100	224042
CPNRE 90° 150X75	6"	150	224043
CPNRE 90° 200X75	8"	200	224044
CPNRE 90° 300X75	12"	300	224045
CPNRE 90° 400X75	16"	400	224046
CPNRE 90° 500X75	20"	500	224047
CPNRE 90° 600X75	24"	600	224048

B = 100...200 2x JUNRE H75 (224218) + 8/100 x B1 (204356 EZ)
 B = 300...600 2x JUNRE H75 (224218) + 1x JUNREC (224252) + 10/100 x B1 (204356 EZ)

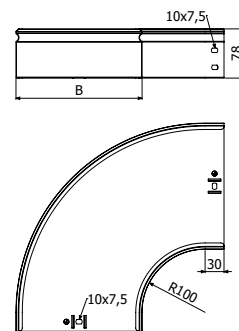

TCPNRE 90°



	larghezza		Zincato Sendzimir
	inch	mm	
90° TCPNRE 100	4"	100	224063
90° TCPNRE 150	6"	150	224064
90° TCPNRE 200	8"	200	224065
90° TCPNRE 300	12"	300	224066
90° TCPNRE 400	16"	400	224067
90° TCPNRE 500	20"	500	224068
90° TCPNRE 600	24"	600	224069

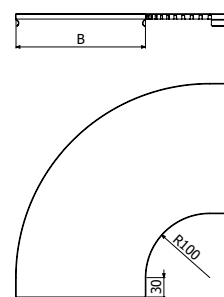

CPNRE 45°

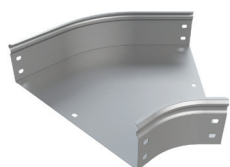

	larghezza		Zincato Sendzimir
	inch	mm	
CPNRE 45° 100X75	4"	100	224056
CPNRE 45° 150X75	6"	150	224057
CPNRE 45° 200X75	8"	200	224058
CPNRE 45° 300X75	12"	300	224059
CPNRE 45° 400X75	16"	400	224060
CPNRE 45° 500X75	20"	500	224061
CPNRE 45° 600X75	24"	600	224062

B = 100...200 2x JUNRE H75 (224218) + 8/100 x B1 (204356 EZ)
 B = 300...600 2x JUNRE H75 (224218) + 1x JUNREC (224252) + 10/100 x B1 (204356 EZ)

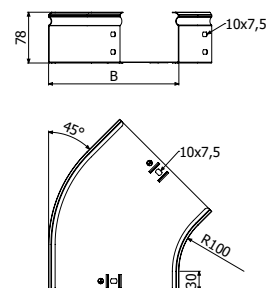

TCPNRE 45°

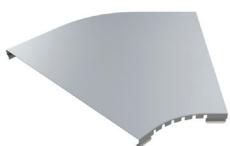

	larghezza		Zincato Sendzimir
	inch	mm	
45° TCPNRE 100	4"	100	224070
45° TCPNRE 150	6"	150	224071
45° TCPNRE 200	8"	200	224072
45° TCPNRE 300	12"	300	224073
45° TCPNRE 400	16"	400	224074
45° TCPNRE 500	20"	500	224075
45° TCPNRE 600	24"	600	224076

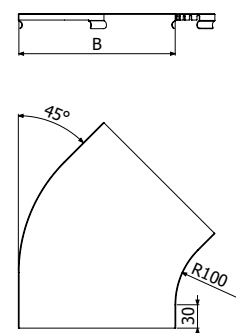

CCNRE 90°

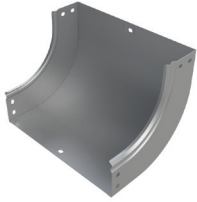

	Larghezza		Zincato Sendzimir
	inch	mm	
CCNRE 90° 100X75	4"	100	224084
CCNRE 90° 150X75	6"	150	224085
CCNRE 90° 200X75	8"	200	224086
CCNRE 90° 300X75	12"	300	224087
CCNRE 90° 400X75	16"	400	224088
CCNRE 90° 500X75	20"	500	224089
CCNRE 90° 600X75	24"	600	224090

B = 100...200 2xJUNRE H75 (224218) + 8/100 x B1 (204356 EZ)
 B = 300...600 2xJUNRE H75 (224218) + 1xJUNREC (224252) + 10/100 x B1 (204356 EZ)

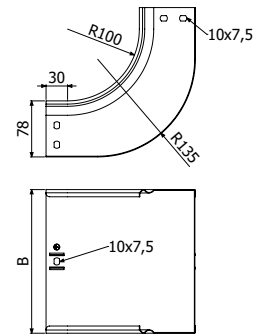

TCCNRE 90°

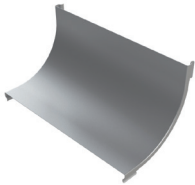

	Larghezza		Zincato Sendzimir
	inch	mm	
90° TCCNRE 100	4"	100	224105
90° TCCNRE 150	6"	150	224106
90° TCCNRE 200	8"	200	224107
90° TCCNRE 300	12"	300	224108
90° TCCNRE 400	16"	400	224109
90° TCCNRE 500	20"	500	224110
90° TCCNRE 600	24"	600	224111

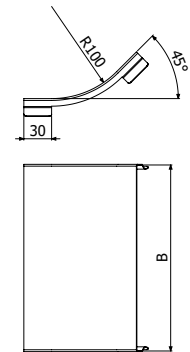

CCNRE 45°

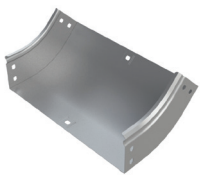

	Larghezza		Zincato Sendzimir
	inch	mm	
CCNRE 45° 100X75	4"	100	224098
CCNRE 45° 150X75	6"	150	224099
CCNRE 45° 200X75	8"	200	224100
CCNRE 45° 300X75	12"	300	224101
CCNRE 45° 400X75	16"	400	224102
CCNRE 45° 500X75	20"	500	224103
CCNRE 45° 600X75	24"	600	224104

B = 100...200 2xJUNRE H75 (224218) + 8/100 x B1 (204356 EZ)
 B = 300...600 2xJUNRE H75 (224218) + 1xJUNREC (224252) + 10/100 x B1 (204356 EZ)

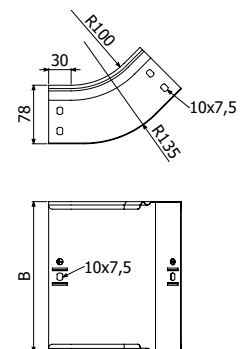

TCCNRE 45°



	Larghezza		Zincato Sendzimir
	inch	mm	
45° TCCNRE 100	4"	100	224112
45° TCCNRE 150	6"	150	224113
45° TCCNRE 200	8"	200	224114
45° TCCNRE 300	12"	300	224115
45° TCCNRE 400	16"	400	224116
45° TCCNRE 500	20"	500	224117
45° TCCNRE 600	24"	600	224118

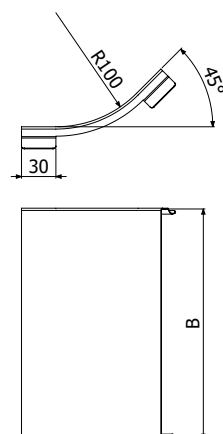

CXNRE 90°

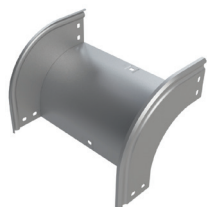

	larghezza		Zincato Sendzimir
	inch	mm	
CXNRE 90° 100X75	4"	100	224126
CXNRE 90° 150X75	6"	150	224127
CXNRE 90° 200X75	8"	200	224128
CXNRE 90° 300X75	12"	300	224129
CXNRE 90° 400X75	16"	400	224130
CXNRE 90° 500X75	20"	500	224131
CXNRE 90° 600X75	24"	600	224132

B = 100...200 2xJUNRE H75 (224218) + 4/100 x B1 (204356 EZ)
 B = 300...600 2xJUNRE H75 (224218) + 1xJUNREC (224252) + 6/100 x B1 (204356 EZ)

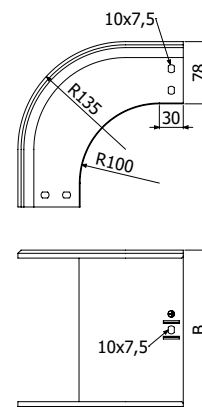

TCXNRE 90°

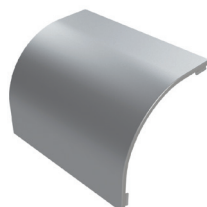

	larghezza		Zincato Sendzimir
	inch	mm	
90° TCXNRE 100	4"	100	224154
90° TCXNRE 150	6"	150	224155
90° TCXNRE 200	8"	200	224156
90° TCXNRE 300	12"	300	224157
90° TCXNRE 400	16"	400	224158
90° TCXNRE 500	20"	500	224159
90° TCXNRE 600	24"	600	224160

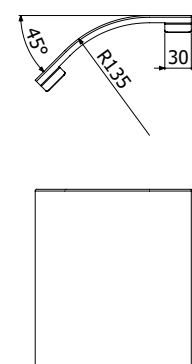

CXNRE 45°



	larghezza		Zincato Sendzimir
	inch	mm	
CXNRE 45° 100X75	4"	100	224140
CXNRE 45° 150X75	6"	150	224141
CXNRE 45° 200X75	8"	200	224142
CXNRE 45° 300X75	12"	300	224143
CXNRE 45° 400X75	16"	400	224144
CXNRE 45° 500X75	20"	500	224145
CXNRE 45° 600X75	24"	600	224146

B = 100...200 2xJUNRE H75 (224218) + 8/100 x B1 (204356 EZ)
 B = 300...600 2xJUNRE H75 (224218) + 1xJUNREC (224252) + 10/100 x B1 (204356 EZ)

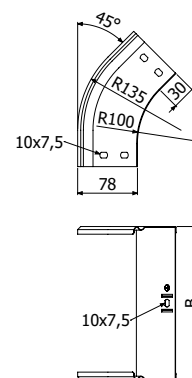

TCXNRE 45°

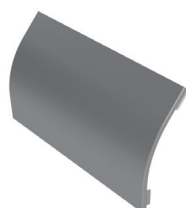

	larghezza		Zincato Sendzimir
	inch	mm	
45° TCXNRE 100	4"	100	224168
45° TCXNRE 150	6"	150	224169
45° TCXNRE 200	8"	200	224170
45° TCXNRE 300	12"	300	224171
45° TCXNRE 400	16"	400	224172
45° TCXNRE 500	20"	500	224173
45° TCXNRE 600	24"	600	224174

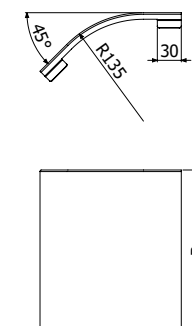

TENRE

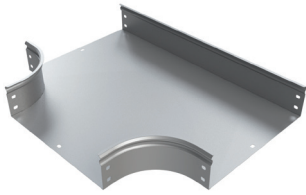

	larghezza		Zincato Sendzimir
	inch	mm	
TENRE 100X75	4"	100	224182
TENRE 150X75	6"	150	224183
TENRE 200X75	8"	200	224184
TENRE 300X75	12"	300	224185
TENRE 400X75	16"	400	224186
TENRE 500X75	20"	500	224187
TENRE 600X75	24"	600	224188

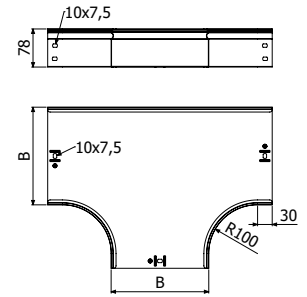

 B = 100...200 2xJUNRE H75 (224218) + 8/100 x B1 (204356 EZ)
 B = 300...600 2xJUNRE H75 (224218) + 1xJUNREC (224252) + 10/100 x B1 (204356 EZ)

TTNRE

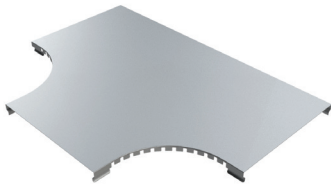

	larghezza		Zincato Sendzimir
	inch	mm	
TTNRE 100	4"	100	224189
TTNRE 150	6"	150	224190
TTNRE 200	8"	200	224191
TTNRE 300	12"	300	224192
TTNRE 400	16"	400	224193
TTNRE 500	20"	500	224194
TTNRE 600	24"	600	224195

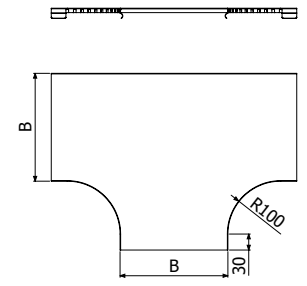

CRNRE

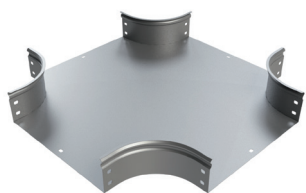

	larghezza		Zincato Sendzimir
	inch	mm	
CRNRE 100X75	4"	100	224203
CRNRE 150X75	6"	150	224204
CRNRE 200X75	8"	200	224205
CRNRE 300X75	12"	300	224206
CRNRE 400X75	16"	400	224207
CRNRE 500X75	20"	500	224208
CRNRE 600X75	24"	600	224209

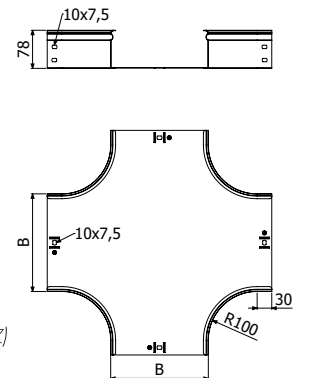

 B = 100...200 2xJUNRE H75 (224218) + 8/100 x B1 (204356 EZ)
 B = 300...600 2xJUNRE H75 (224218) + 1xJUNREC (224252) + 10/100 x B1 (204356 EZ)

TCRNRE

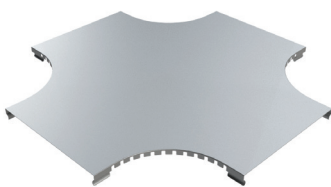

	larghezza		Zincato Sendzimir
	inch	mm	
TCRNRE 100	4"	100	224210
TCRNRE 150	6"	150	224211
TCRNRE 200	8"	200	224212
TCRNRE 300	12"	300	224213
TCRNRE 400	16"	400	224214
TCRNRE 500	20"	500	224215
TCRNRE 600	24"	600	224216

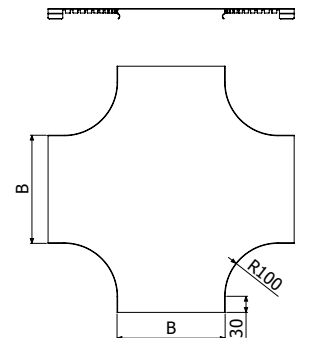

ASNRE



	Larghezza		Zincato Sendzimir
	inch	mm	
ASNRE 100X75	4"	100	224230
ASNRE 150X75	6"	150	224231
ASNRE 200X75	8"	200	224232
ASNRE 300X75	12"	300	224233
ASNRE 400X75	16"	400	224234
ASNRE 500X75	20"	500	224235
ASNRE 600X75	24"	600	224236

6/100 x B1 (204356 EZ)

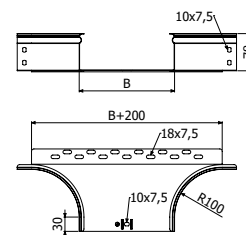

TASNRE

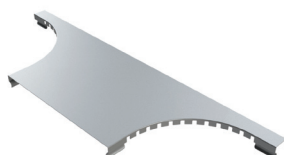

	Larghezza		Zincato Sendzimir
	inch	mm	
TASNRE 100	4"	100	224237
TASNRE 150	6"	150	224238
TASNRE 200	8"	200	224239
TASNRE 300	12"	300	224240
TASNRE 400	16"	400	224241
TASNRE 500	20"	500	224242
TASNRE 600	24"	600	224243

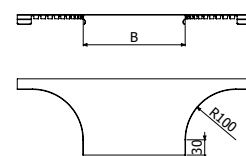

TFNRE

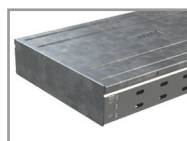

	Larghezza		Zincato Sendzimir
	inch	mm	
TFNRE 100X75	4"	100	224853
TFNRE 150X75	6"	150	224854
TFNRE 200X75	8"	200	224855
TFNRE 300X75	12"	300	224856
TFNRE 400X75	16"	400	224857
TFNRE 500X75	20"	500	224858
TFNRE 600X75	24"	600	224859

4/100 x B1 (204356 EZ)

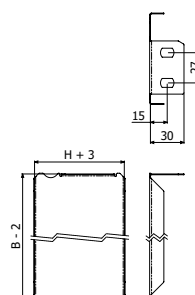

ACNRE

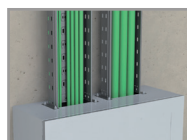

	Zincato Sendzimir
ACNRE H75	224860

4/100 x B1 (204356 EZ)

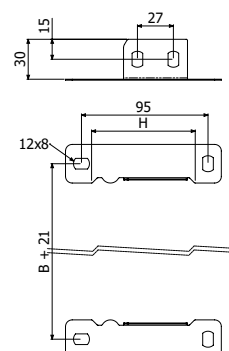

CSNRE SGHEMBA UNIVERSALE SINISTRA IN DISCESA

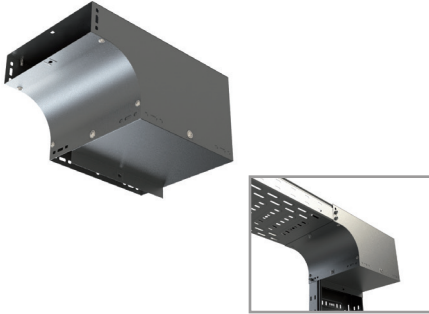

	larghezza		Zincato Sendzimir
	inch	mm	
SINISTRA IN DISCESA 100X75	4"	100	224549
SINISTRA IN DISCESA 150X75	6"	150	224550
SINISTRA IN DISCESA 200X75	8"	200	224551
SINISTRA IN DISCESA 300X75	12"	300	224552
SINISTRA IN DISCESA 400X75	16"	400	224553
SINISTRA IN DISCESA 500X75	20"	500	224554
SINISTRA IN DISCESA 600X75	24"	600	224555

B = 100...200 2x JUNRE H75 (224218) + 8/100 x B1 (204356 EZ)
 B = 300...600 2x JUNRE H75 (224218) + 1x JUNREC (224252) + 10/100 x B1 (204356 EZ)

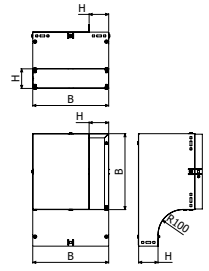

CSNRE SGHEMBA UNIVERSALE DESTRA IN DISCESA

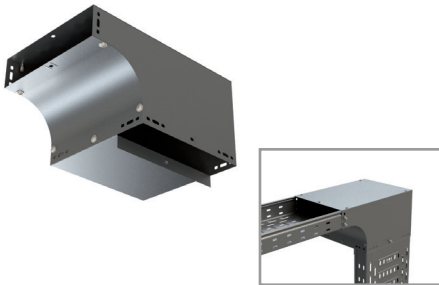

	larghezza		Zincato Sendzimir
	inch	mm	
DESTRA IN DISCESA 100X75	4"	100	224549
DESTRA IN DISCESA 150X75	6"	150	224550
DESTRA IN DISCESA 200X75	8"	200	224551
DESTRA IN DISCESA 300X75	12"	300	224552
DESTRA IN DISCESA 400X75	16"	400	224553
DESTRA IN DISCESA 500X75	20"	500	224554
DESTRA IN DISCESA 600X75	24"	600	224555

B = 100...200 2x JUNRE H75 (224218) + 8/100 x B1 (204356 EZ)
 B = 300...600 2x JUNRE H75 (224218) + 1x JUNREC (224252) + 10/100 x B1 (204356 EZ)

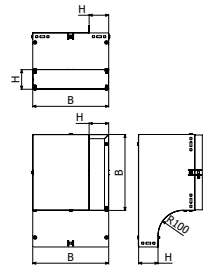

CSNRE SGHEMBA UNIVERSALE IN DISCESA CON INVERSIONE DI PIANO

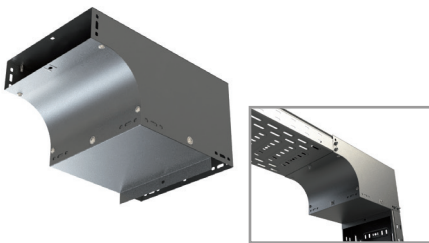

	larghezza		Zincato Sendzimir
	inch	mm	
DISCESA CON INVERSIONE DI PIANO 100X75	4"	100	224549
DISCESA CON INVERSIONE DI PIANO 150X75	6"	150	224550
DISCESA CON INVERSIONE DI PIANO 200X75	8"	200	224551
DISCESA CON INVERSIONE DI PIANO 300X75	12"	300	224552
DISCESA CON INVERSIONE DI PIANO 400X75	16"	400	224553
DISCESA CON INVERSIONE DI PIANO 500X75	20"	500	224554
DISCESA CON INVERSIONE DI PIANO 600X75	24"	600	224555

B = 100...200 2x JUNRE H75 (224218) + 8/100 x B1 (204356 EZ)
 B = 300...600 2x JUNRE H75 (224218) + 1x JUNREC (224252) + 10/100 x B1 (204356 EZ)

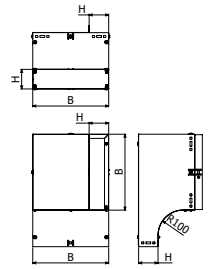

CSNRE SGHEMBA UNIVERSALE SINISTRA IN SALITA

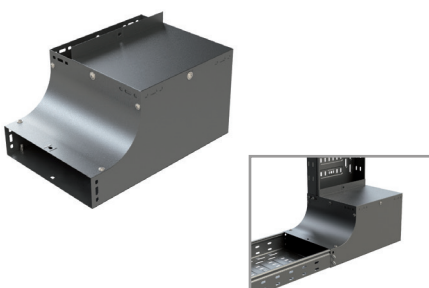

	larghezza		Zincato Sendzimir
	inch	mm	
SINISTRA IN SALITA 100X75	4"	100	224549
SINISTRA IN SALITA 150X75	6"	150	224550
SINISTRA IN SALITA 200X75	8"	200	224551
SINISTRA IN SALITA 300X75	12"	300	224552
SINISTRA IN SALITA 400X75	16"	400	224553
SINISTRA IN SALITA 500X75	20"	500	224554
SINISTRA IN SALITA 600X75	24"	600	224555

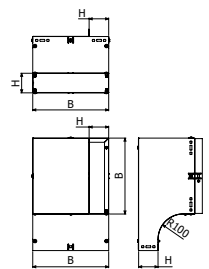

B = 100...200 2x JUNRE H75 (224218) + 8/100 x B1 (204356 EZ)
 B = 300...600 2x JUNRE H75 (224218) + 1x JUNREC (224252) + 10/100 x B1 (204356 EZ)

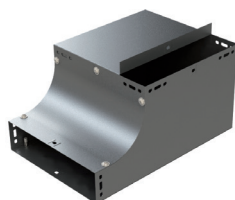

CSNRE SGHEMBA UNIVERSALE DESTRA IN SALITA



	Larghezza		Zincato Sendzimir
	inch	mm	
DESTRA IN SALITA 100X75	4"	100	224549
DESTRA IN SALITA 150X75	6"	150	224550
DESTRA IN SALITA 200X75	8"	200	224551
DESTRA IN SALITA 300X75	12"	300	224552
DESTRA IN SALITA 400X75	16"	400	224553
DESTRA IN SALITA 500X75	20"	500	224554
DESTRA IN SALITA 600X75	24"	600	224555

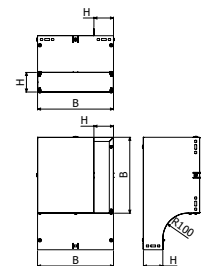

 B = 100...200 2x JUNRE H75 (224218) + 8/100 x B1 (204356 EZ)
 B = 300...600 2x JUNRE H75 (224218) + 1x JUNRE-C (224252) + 10/100 x B1 (204356 EZ)

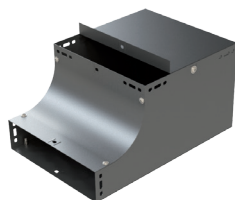

CSNRE SGHEMBA UNIVERSALE IN SALITA CON INVERSIONE DI PIANO



	Larghezza		Zincato Sendzimir
	inch	mm	
SALITA CON INVERSIONE DI PIANO 100X75	4"	100	224549
SALITA CON INVERSIONE DI PIANO 150X75	6"	150	224550
SALITA CON INVERSIONE DI PIANO 200X75	8"	200	224551
SALITA CON INVERSIONE DI PIANO 300X75	12"	300	224552
SALITA CON INVERSIONE DI PIANO 400X75	16"	400	224553
SALITA CON INVERSIONE DI PIANO 500X75	20"	500	224554
SALITA CON INVERSIONE DI PIANO 600X75	24"	600	224555

 B = 100...200 2x JUNRE H75 (224218) + 8/100 x B1 (204356 EZ)
 B = 300...600 2x JUNRE H75 (224218) + 1x JUNRE-C (224252) + 10/100 x B1 (204356 EZ)

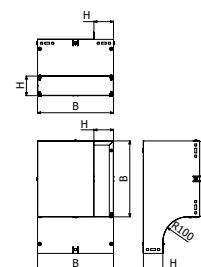

CSNRE SGHEMBA UNIVERSALE: TUTTE LE APPLICAZIONI

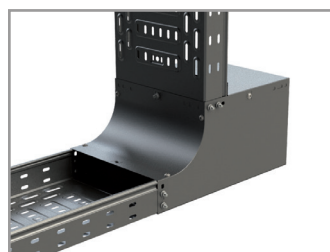
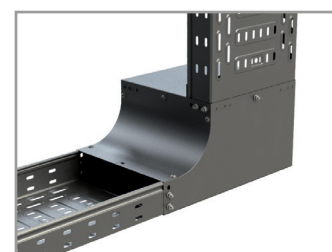
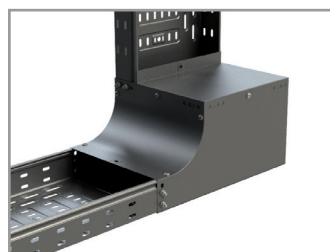
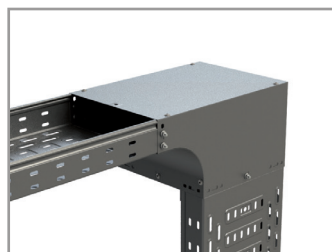

TEVNRE "T" IN DISCESA CON VARIAZIONE DI PIANO

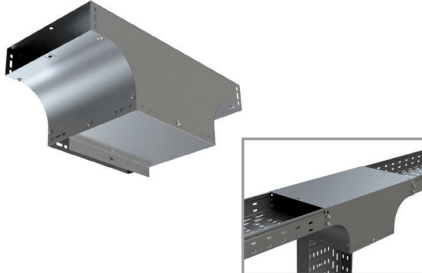

	Larghezza		Zincato Sendzimir
	inch	mm	
"T" IN DISCESA CON VARIAZIONE DI PIANO 100X75	4"	100	224556
"T" IN DISCESA CON VARIAZIONE DI PIANO 150X75	6"	150	224557
"T" IN DISCESA CON VARIAZIONE DI PIANO 200X75	8"	200	224558
"T" IN DISCESA CON VARIAZIONE DI PIANO 300X75	12"	300	224559
"T" IN DISCESA CON VARIAZIONE DI PIANO 400X75	16"	400	224560
"T" IN DISCESA CON VARIAZIONE DI PIANO 500X75	20"	500	224561
"T" IN DISCESA CON VARIAZIONE DI PIANO 600X75	24"	600	224562

B = 100...200 2xJUNRE H75 (224218) + 8/100 x B1 (204356 EZ)
 B = 300...600 2xJUNRE H75 (224218) + 1xJUNREC (224252) + 10/100 x B1 (204356 EZ)

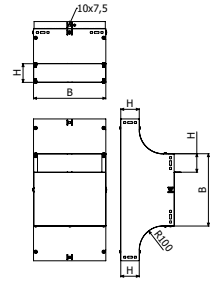

TVNRE "T" IN DISCESA

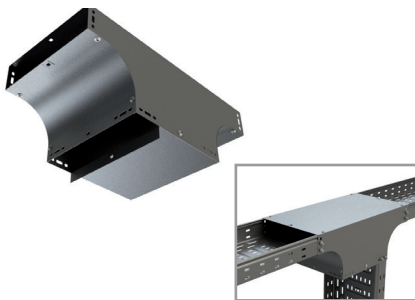

	Larghezza		Zincato Sendzimir
	inch	mm	
"T" IN DISCESA 100X75	4"	100	224556
"T" IN DISCESA 150X75	6"	150	224557
"T" IN DISCESA 200X75	8"	200	224558
"T" IN DISCESA 300X75	12"	300	224559
"T" IN DISCESA 400X75	16"	400	224560
"T" IN DISCESA 500X75	20"	500	224561
"T" IN DISCESA 600X75	24"	600	224562

B = 100...200 2xJUNRE H75 (224218) + 8/100 x B1 (204356 EZ)
 B = 300...600 2xJUNRE H75 (224218) + 1xJUNREC (224252) + 10/100 x B1 (204356 EZ)

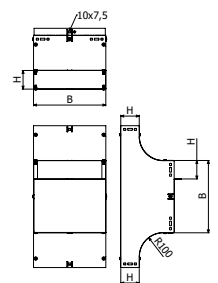

TEVNRE "T" IN SALITA CON VARIAZIONE DI PIANO

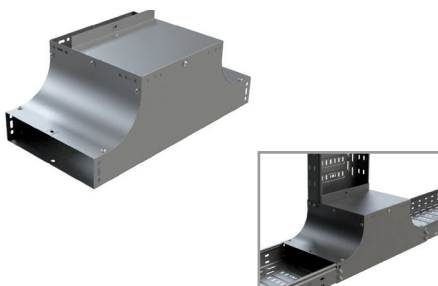

	Larghezza		Zincato Sendzimir
	inch	mm	
"T" IN SALITA CON VARIAZIONE DI PIANO 100X75	4"	100	224556
"T" IN SALITA CON VARIAZIONE DI PIANO 150X75	6"	150	224557
"T" IN SALITA CON VARIAZIONE DI PIANO 200X75	8"	200	224558
"T" IN SALITA CON VARIAZIONE DI PIANO 300X75	12"	300	224559
"T" IN SALITA CON VARIAZIONE DI PIANO 400X75	16"	400	224560
"T" IN SALITA CON VARIAZIONE DI PIANO 500X75	20"	500	224561
"T" IN SALITA CON VARIAZIONE DI PIANO 600X75	24"	600	224562

B = 100...200 2xJUNRE H75 (224218) + 8/100 x B1 (204356 EZ)
 B = 300...600 2xJUNRE H75 (224218) + 1xJUNREC (224252) + 10/100 x B1 (204356 EZ)

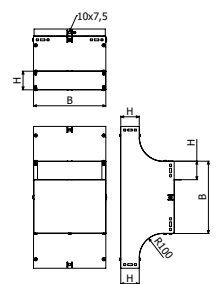

TEVNRE "T" IN SALITA

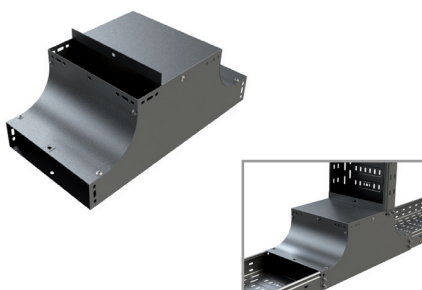

	Larghezza		Zincato Sendzimir
	inch	mm	
"T" IN SALITA 100X75	4"	100	224556
"T" IN SALITA 150X75	6"	150	224557
"T" IN SALITA 200X75	8"	200	224558
"T" IN SALITA 300X75	12"	300	224559
"T" IN SALITA 400X75	16"	400	224560
"T" IN SALITA 500X75	20"	500	224561
"T" IN SALITA 600X75	24"	600	224562

B = 100...200 2xJUNRE H75 (224218) + 8/100 x B1 (204356 EZ)
 B = 300...600 2xJUNRE H75 (224218) + 1xJUNREC (224252) + 10/100 x B1 (204356 EZ)

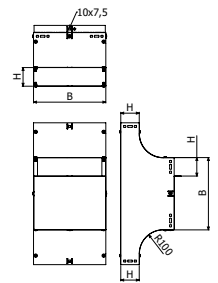

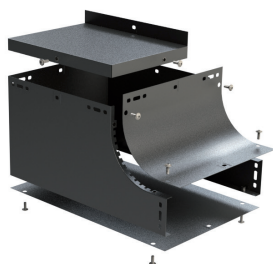

SGHEMBA SINISTRA
IN DISCESA

SGHEMBA DESTRA
IN DISCESA

SGHEMBA SINISTRA
IN SALITA

SGHEMBA DESTRA
IN SALITA

SGHEMBA IN DISCESA
CON INVERSIONE
DI PIANO

SGHEMBA IN SALITA
CON INVERSIONE
DI PIANO

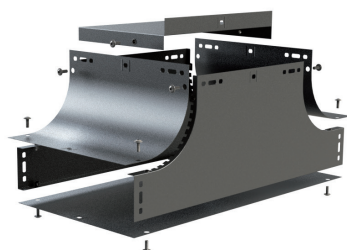
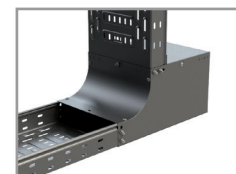
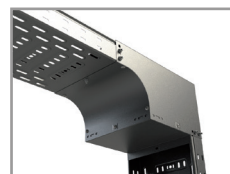
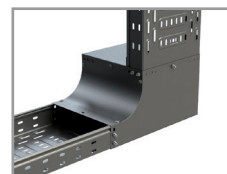
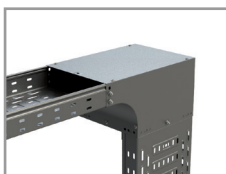
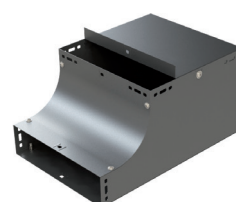
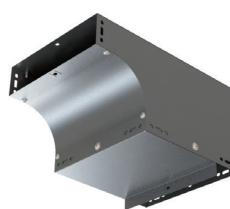
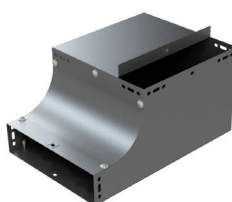
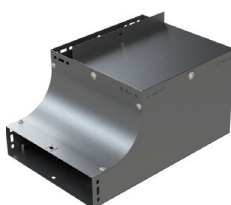
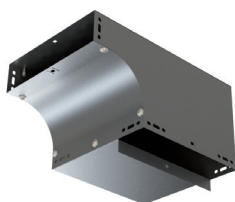
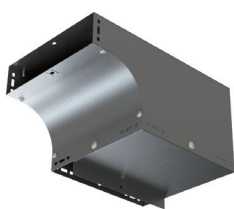

"T" IN DISCESA CON
VARIAZIONE DI PIANO

"T" IN DISCESA

"T" IN SALITA CON
VARIAZIONE DI PIANO

"T" IN SALITA

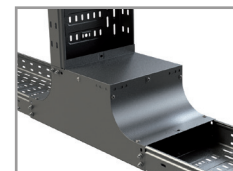
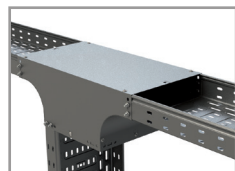
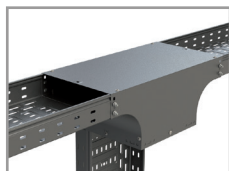
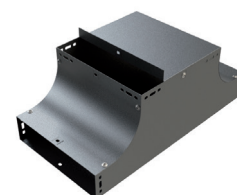
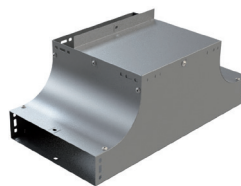
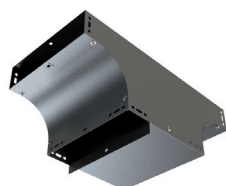
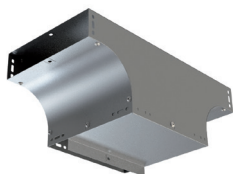

RENRE

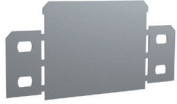

	Larghezza		Zincato Sendzimir
	inch	mm	
RENRE-50X75	2"	50	224799
RENRE-100X75	4"	100	224800

4/100 x B1 (204356 EZ)

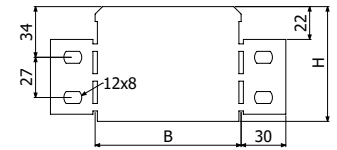

SUCP



	Larghezza		Zincato Sendzimir
	inch	mm	
SUCP	4"	100	214255

2/100 x B1 (204356 EZ)

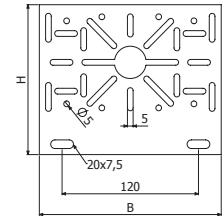

PS

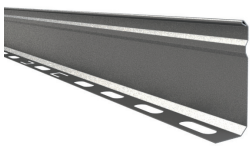

L = 10 FT / 3 m

	Larghezza		Zincato Sendzimir
	inch	mm	
PS H75	3"	150	203477

4/100 x B1 (204356 EZ)

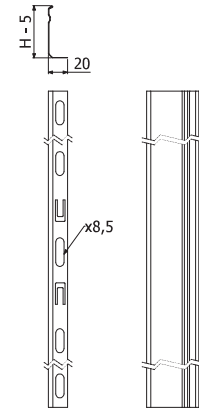

GIUNZIONE

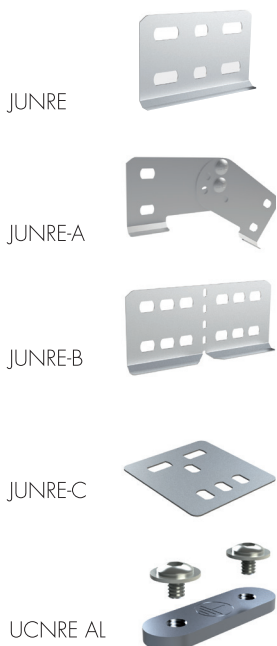

	RIVESTIMENTO
	REF. PG
JUNRE H75	224218
JUNRE-A H75	224220
JUNRE-B H75	224222
JUNRE-C H75	224852
UCNRE AL	224861
B1	2/4356

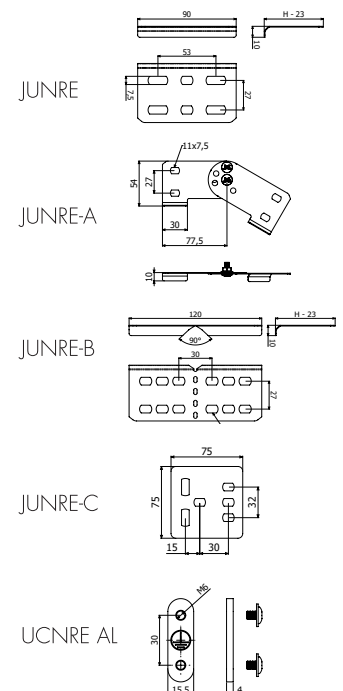
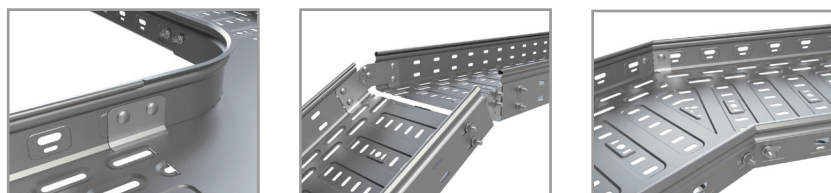



Basor Electric s.r.l.

Via B. Franklin, 31
43122 Parma

commerciale@basor.com

+39 0521 798360



[@basorelectric](https://twitter.com/basorelectric)



[www.linkedin.com/
company/basor-electric-sa](https://www.linkedin.com/company/basor-electric-sa)



[www.youtube.com/user/
basorelectric](https://www.youtube.com/user/basorelectric)