

SIRENA



#more**than**bright**ideas**

Colonne modulari a LED

LED modular stacklights

Colonnes modulaires à LED

EOS





EOS: soluzioni smart per ogni esigenza di segnalazione

- **Design liscio** che previene l'accumulo di polvere sulla superficie
- Ideale per **ambienti con alta luminosità** grazie alla lente neutra in opalino che permette una netta distinzione tra lo stato ON e OFF della colonna
- Perfetta **distribuzione della luce a 360°**
- Elevata protezione all'acqua **IP69K**
- **Versatilità di cablaggio** (NPN/PNP)
- Fino a **5 moduli luminosi + acustica**
- **2 livelli sonori** per i moduli acustici
- Predisposizione per connettività **Smart Factory 4.0**



EOS: smart solutions for all signaling needs

- **Smooth design** that prevents dirt gathering on the surface
- Ideal for **environments with high brightness** thanks to the clear opaline lens that allows a clear distinction between the ON and OFF state of the stacklight
- Perfect **light distribution at 360°**
- High water protection **IP69K**
- **Wiring versatility** (NPN/PNP)
- Up to **5 luminous modules + sounder**
- **2 sound levels** for the acoustic modules
- **Smart Factory 4.0** networking capabilities



EOS: solutions intelligentes pour tous les besoins de signalisation

- **Design lisse** qui empêche l'accumulation de poussière en surface
- Idéal pour les **environnements fortement lumineux** grâce à ses lentilles neutres en opalino qui permettent une nette distinction entre l'état ON et l'état OFF de la colonne
- Parfaite **distribution de la lumière à 360°**
- Protection élevée à l'eau **IP69K**
- **Polyvalence de câblage** (NPN/PNP)
- Jusqu'à **5 modules lumineux + acoustique**
- **2 niveaux sonores** pour les modules acoustiques
- Predisposition pour **connectivité Smart Factory 4.0**

EOS WM



EOS WM

Corpo / Body / Corps

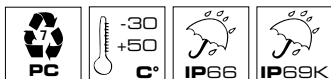

Codici / Codes

EOS WM

LT	12/24V ACDC	94730
HT	110/240V AC	94720

EOS WM è il modulo di cablaggio della colonna luminosa EOS. Dispone di un contatto comune + 7 contatti indipendenti per consentire l'assemblaggio di un massimo di 7 moduli luminosi* oppure 5 moduli luminosi + 1 modulo acustico (2 canali).

*Il modulo EOS LM RGB utilizza 3 dei 7 contatti disponibili sul modulo di cablaggio.

EOS WM è fornito con cappello per la chiusura superiore della colonna, nel caso non venga impiegato il modulo acustico.

Tensione operativa

12/24V ACDC, 110/240V AC +/-10%

Caratteristiche meccaniche

Polycarbonato autoestinguente ad alta resistenza agli impatti (IK 06), adatto per utilizzo esterno grazie al grado di protezione IP66-IP69K, garantito dalla guarnizione O-ring in EPDM presente su ogni modulo.

Certificazioni / Certifications

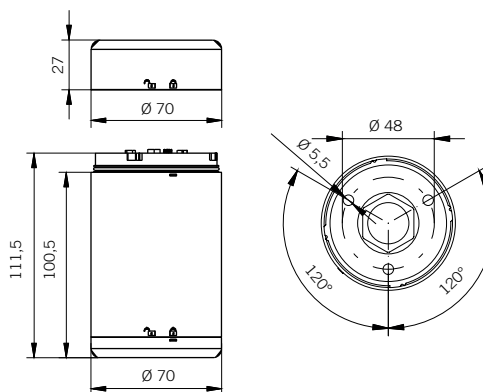

WM



EOS WM is the wiring module for the EOS stack light range. With 7 electrical contacts, it allows assembly of maximum 7 light modules* or 5 light modules + 1 acoustic module (2 channels).

*EOS LM RGB module uses 3 of the 7 available contacts of the wiring module.

EOS WM is supplied with a top cap for closure of the stacklight when an acoustic module is not installed.

Voltages

12/24V ACDC, 110/240V AC +/-10%

Mechanical features

Self-extinguishing PC body with high impact resistance (IK 06), suitable for outdoor applications thanks to the IP66-IP69K protection grade, guaranteed by an EPDM O-ring gasket on each module.



EOS WM est l'élément de câblage de la colonne lumineuse EOS. Il prévoit 7 connexions électriques permettant le montage au maximum de 7 éléments lumineux* ou 5 éléments lumineux + 1 élément acoustique (2 canaux).

*L'élément EOS LM RGB utilise 3 des 7 contacts disponibles sur l'élément de câblage.

EOS WM est fourni avec un couvercle de fermeture à utiliser quand l'élément acoustique n'est pas installé.

Tension d'utilisation

12/24V ACDC, 110/240V AC +/-10%

Caractéristiques mécaniques

Polycarbonate autoextinguible, haute résistance aux chocs (IK 06), adapté pour une utilisation à l'extérieur grâce au degré de protection IP66-IP69K, garanti par un joint O-ring en EPDM sur chaque élément.

EOS LM



EOS LM
EOS LM RGB

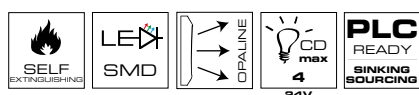
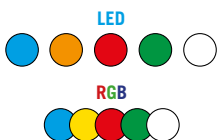

EOS LM

V DC	12	-	24	-	-	-
V AC	-	12	-	24	110	240
mA (max)	110	145	65	95	25	20

EOS RGB

V DC	12	-	24	-	-	-
V AC	-	12	-	24	110	240
mA (max)	150	200	85	120	40	25

Codici / Codes

EOS LM

- 94721
- 94722
- 94723
- 94724
- 94726
- 94727

EOS LM: modulo luminoso a LED integrati, disponibile in 5 colori a luce fissa, con possibilità di programmare ulteriori effetti luminosi tramite PLC.

EOS LM RGB: modulo luminoso a LED multicolore che permette di selezionare tra cinque colori diversi a luce fissa, con possibilità di programmare ulteriori effetti luminosi tramite PLC.

EOS LM e **EOS LM RGB** offrono una manutenzione nulla, grazie alla tecnologia a LED che garantisce 100.000* ore d'utilizzo.

* In condizioni normali, in assenza di vibrazioni e sbalzi di temperatura

Tensione operativa

A seconda del modulo di cablaggio WM selezionato

con **WM LT:** 12/24V ACDC +/-10%

con **WM HT:** 110/240V AC +/-10%

Caratteristiche meccaniche

Policarbonato autoestinguente ad alta resistenza agli impatti (IK 06), adatto per utilizzo esterno grazie al grado di protezione IP66-IP69K, garantito dalla guarnizione O-ring in EPDM presente su ogni modulo.

Caratteristiche luminose

Lente neutra in opalino con fonte luminosa a LED colorata.

EOS LM: 12 LED ad elevata luminosità

EOS LM RGB: 8 LED RGB

Rifrattore con rigatura verticale per una perfetta distribuzione della luce a 360°. Effetto luminoso: luce fissa. Possibilità di effettuare ulteriori effetti luminosi tramite PLC.

Certificazioni / Certifications

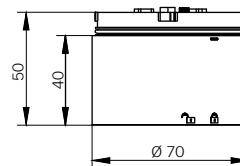

EOS LM
EOS RGB



EOS LM: LED integrated signaling module, available in 5 colors with steady light, other luminous effects via PLC are possible.

EOS LM RGB: multicolor LED light module, allowing five different colors with steady light, other luminous effects via PLC are possible.

EOS LM and **EOS LM RGB** offer virtually zero maintenance thanks to the built-in LED technology that guarantees up to 100.000* hours of product life.

* At normal conditions, without vibrations and heavy temperature changes

Voltages

According to selected wiring module WM

with **WM LT:** 12/24V ACDC +/-10%

with **WM HT:** 110/240V AC +/-10%

Mechanical features

Self-extinguishing PC with high impact resistance IK06, suitable for outdoor use thanks to the IP66 -IP69K protection grade, guaranteed by an EPDM O-ring gasket on each module.

Optical features

Opaline clear lens with colored LED light source.

EOS LM: 12 superbright LEDs

EOS LM RGB: 8 RGB LEDs

The vertically lined refractor allows a perfect light distribution over 360°. Steady light. Other luminous effects via PLC.



EOS LM : Élément lumineux à LED intégrées disponible en 5 couleurs à lumière fixe. Plusieurs effets lumineux sont possibles via PLC.

EOS LM RGB : Élément lumineux à LED multicolore qui permet de sélectionner une des cinq couleurs différentes à lumière fixe. Plusieurs effets lumineux sont possibles via PLC.

EOS LM et **EOS LM RGB** offrent un entretien quasi-nul grâce à la technologie à LED intégrée qui garantit jusqu'à 100.000* heures de vie au produit.

* Dans des conditions normales, sans vibrations et sans variations importantes de température

Tension d'utilisation

En fonction de l'élément de câblage WM choisi

avec **WM LT :** 12/24V ACDC +/-10%

avec **WM HT :** 110/240V AC +/-10%

Caractéristiques mécaniques

PC autoextinguible, haute résistance aux chocs IK06, adapté pour une utilisation à l'extérieur grâce au degré de protection IP66-IP69K, garanti par un joint O-ring en EPDM sur chaque élément.

Caractéristiques optiques

Lentille opaline neutre avec source lumineuse à LED colorée.

EOS LM : 12 LED à haute luminosité

EOS LM RGB : 8 LED RGB

Le réflecteur verticalement strié permet une répartition parfaite de la lumière sur 360°. Lumière fixe. Plusieurs effets lumineux possibles via PLC.

EOS

ACUSTICHE/SOUNDERS/ACOUSTIQUES



EOS SOUNDER

EOS SOUNDER A+

Corpo / Body / Corps

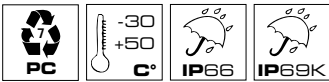

EOS SOUNDER

V DC	12	-	24	-	-	-
V AC	-	12	-	24	110	240
mA	60	150	40	100	20	15
dB(A)1m	75	75	75	75	75	75

EOS SOUNDER A+

V DC	12	-	24	-	-	-
V AC	-	12	-	24	110	240
mA	260	540	260	580	70	35
dB(A)1m	98	99	100	100	96	97

Codici / Codes

EOS SOUNDER

EOS SOUNDER
EOS SOUNDER A+94728
94729

EOS SOUNDER: Modulo acustico piezoelettrico
EOS SOUNDER A+: Modulo acustico magnetodinamico

EOS SOUNDER e EOS SOUNDER A+ offrono 12 tipologie di suono disposte su 2 canali (8+4). È possibile utilizzare entrambi i canali utilizzando 2 dei 7 contatti disponibili sul modulo di cablaggio. Per ogni canale è possibile selezionare il suono tramite dip-switch.

Tensione operativa

A seconda del modulo di cablaggio WM selezionato:
con WM LT: 12/24V ACDC +/-10%
con WM HT: 110/240V AC +/-10%

Caratteristiche meccaniche

Policarbonato autoestinguente ad alta resistenza agli impatti (IK 06), adatto per utilizzo esterno grazie al grado di protezione IP66-IP69K, garantito dalla guarnizione O-ring in EPDM presente su ogni modulo.

Caratteristiche acustiche

EOS SOUNDER: Unità piezoelettrica

EOS SOUNDER A+: Unità magnetodinamica

Frequenze miste 500-2800Hz (a seconda della tipologia di suono selezionato tramite dip-switch). 8+4 suoni (tipologie miste) su 2 canali.

Certificazioni / Certifications

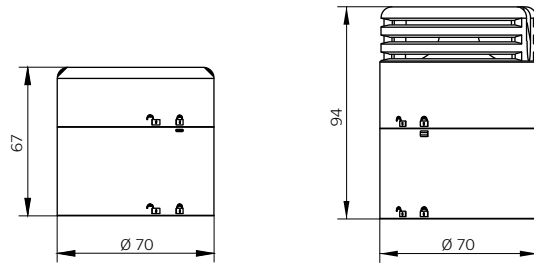
EOS
SOUNDEREOS
SOUNDER A+

EOS SOUNDER: Piezoelectric acoustic module
EOS SOUNDER A+: Magnetodynamic acoustic module

EOS SOUNDER and EOS SOUNDER A+ offer 12 sounds over 2 channels (8+4). It allows using both channels, by connecting 2 of the 7 available contacts of the wiring module. For each channel it is possible to select the sound via dip-switch.

Voltages

According to selected Wiring Module WM:
with WM LT: 12/24V ACDC +/-10%
with WM HT: 110/240V AC +/-10%

Mechanical features

Self-extinguishing PC with high impact resistance IK06, suitable for outdoor use thanks to the IP66-IP69K protection grade, guaranteed by an EPDM O-ring gasket on each module.

Acoustic features

EOS SOUNDER: Piezoelectric unit

EOS SOUNDER A+: Magnetodynamic unit

Mixed frequencies 500-2800Hz (according to the selected tone via dip-switch). 8+4 sounds (mixed types) over 2 channels.



EOS SOUNDER : Élément acoustique piézoélectrique
EOS SOUNDER A+ : Élément acoustique magnétodynamique

EOS SOUNDER et EOS SOUNDER A+ offrent 12 sons sur 2 canaux (8+4). Il permet d'utiliser les deux canaux, en reliant 2 des 7 contacts disponibles sur l'élément de câblage. Il est possible de sélectionner le son pour chaque canal par dip-switch.

Tension d'utilisation

En fonction de l'élément de câblage WM choisi :
avec WM LT: 12/24V ACDC +/-10%
avec WM HT: 110/240V AC +/-10%

Caractéristiques mécaniques

PC autoextinguible, haute résistance aux chocs IK06, adapté pour une utilisation à l'extérieur grâce au degré de protection IP66-IP69K, garanti par un joint O-ring en EPDM sur chaque élément.

Caractéristiques acoustiques

EOS SOUNDER : Élément piézoélectrique
EOS SOUNDER A+ : Élément magnétodynamique
Fréquence mixte 500-2800Hz (sur la base du son choisi par dip-switch). 8+4 sons (tonalités mixtes) sur 2 canaux.

ACCESSORI / ACCESSORIES / ACCESSOIRES



EOS WALL BASE

36911

EOS WALL BASE

Base per fissaggio laterale/a parete

- Base designed for lateral/wall mounting
- Base conçue pour le montage sur surfaces latérales

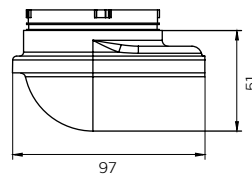
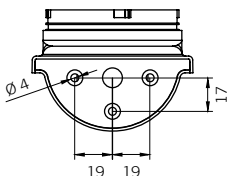

EOS WALL BASE

kg
0,11

Gli accessori TWS sono compatibili anche con le colonne di segnalazione EOS

TWS accessories are also suitable for EOS stacklights

Les accessoires TWS sont compatibles aussi avec les colonnes de signalisation EOS



BS

27760

BS

Base piana per montaggio superficiale

- Flat base for surface mount
- Base pour montage à plat

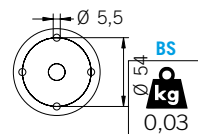
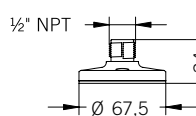

kg
0,03



PR

27761

PR

Prolunga 10 cm

- 10 cm extension
- 10 cm de prolongation

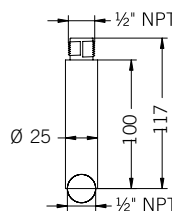

kg
0,03



KIT

27764

KIT

Base piana per montaggio superficiale con estensione di 10 cm

- Flat base for surface mount with 10 cm extension
- Base pour montage à plat avec 10 cm de prolongation

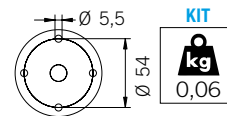
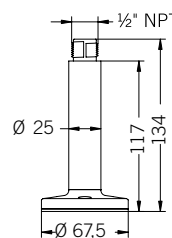

kg
0,06



KIT SS

L10 27765
L20 27766
L40 27767

KIT SS L10 - L20 - L40

Base piana per montaggio superficiale con estensione in acciaio INOX di 10 cm (disponibile anche con misura 20 e 40 cm)

- Flat base for surface mount with 10 cm stainless steel extension (also available in 20 and 40 cm sizes)
- Base pour montage à plat avec extension en acier inoxydable de 10 cm (aussi disponible en taille de 20 et 40 cm)

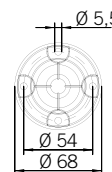
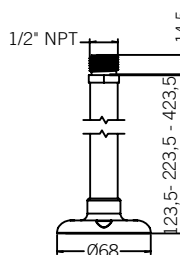

kg
0,14

kg
0,18

kg
0,28

EOS COLONNE PRE-ASSEMBLATE / PRE-ASSEMBLED STACKLIGHTS / COLONNES PRE-ASSEMBLEES

Altre configurazioni disponibili a richiesta / Other configuration available on request / D'autres configurations disponibles sur demande



EOS WM LT + 3LM				
V DC	12	-	24	-
V AC	-	12	-	24
mA*	110	145	65	95

*per modulo
for each module
pour chaque élément

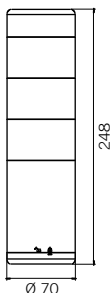

EOS WM LT + 3LM



Codici / Codes

EOS WM LT + 3LM

12/24V DC

36900



EOS WM LT + 2LM				
V DC	12	-	24	-
V AC	-	12	-	24
mA*	110	145	65	95

*per modulo
for each module
pour chaque élément

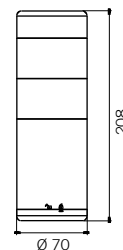

EOS WM LT + 2LM



Codici / Codes

EOS WM LT + 2LM

12/24V DC

36901



EOS WM LT + 3LM + SOUNDER				
V DC	12	-	24	-
V AC	-	12	-	24
mA*	110	145	65	95
mA SOUNDER	60	150	40	100
dB(A)1m	75	75	75	75

*per modulo
for each module
pour chaque élément

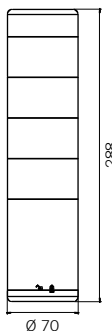

EOS WM LT + 3LM + SOUNDER



Codici / Codes

EOS WM LT + 3LM + SOUNDER

12/24V DC

36904



EOS WM LT + 2LM + SOUNDER				
V DC	12	-	24	-
V AC	-	12	-	24
mA*	110	145	65	95
mA SOUNDER	60	150	40	100
dB(A)1m	75	75	75	75

*per modulo
for each module
pour chaque élément

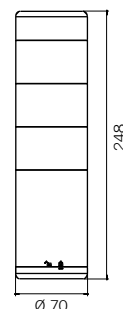

EOS WM LT + 2LM + SOUNDER



Codici / Codes

EOS WM LT + 2LM + SOUNDER

12/24V DC

36903



EOS WM LT + 3LM + SOUNDER A+				
V DC	12	-	24	-
V AC	-	12	-	24
mA*	110	145	65	95
mA SOUNDER	260	540	260	580
dB(A)1m	98	99	100	100

*per modulo
for each module
pour chaque élément

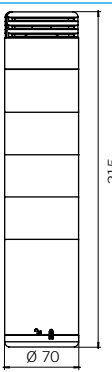

EOS WM LT + 3LM + SOUNDER A+



Codici / Codes

EOS WM LT + 3LM + SOUNDER A+

12/24V DC

36908



EOS WM LT + 2LM + SOUNDER A+				
V DC	12	-	24	-
V AC	-	12	-	24
mA*	110	145	65	95
mA SOUNDER	260	540	260	580
dB(A)1m	98	99	100	100

*per modulo
for each module
pour chaque élément

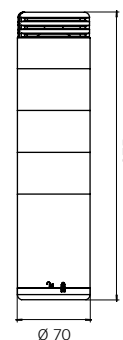

EOS WM LT + 2LM + SOUNDER A+



Codici / Codes

EOS WM LT + 2LM + SOUNDER A+

12/24V DC

36907



EOS WM LT + LM RGB + SOUNDER				
V DC	12	-	24	-
V AC	-	12	-	24
mA RGB	150	200	85	120
mA SOUNDER	60	150	40	100
dB(A)1m	75	75	75	75

Codici / Codes

EOS WM LT + LM RGB + SOUNDER

12/24V DC

36909

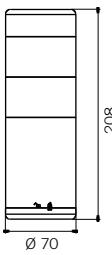

EOS WM LT + LM RGB + SOUNDER



EOS WM LT + LM RGB + SOUNDER A+				
V DC	12	-	24	-
V AC	-	12	-	24
mA RGB	150	200	85	120
mA SOUNDER	260	540	260	580
dB(A)1m	98	99	100	100

Codici / Codes

EOS WM LT + LM RGB + SOUNDER A+

12/24V DC

36910

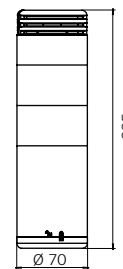

EOS WM LT + LM RGB + SOUNDER A+



#morethanbrightideas

sirena.it

facebook.com/sirenaspa

twitter.com/sirenaspa

plus.google.com/+sirenaspa

linkedin.com/company/sirena-spa

youtube.com/sirenait

instagram.com/sirenaspa74



SIRENA

Sirena SpA
C.so Moncenisio, 5
10090 Rosta (TO)
Italy

T +39 011 95 68 555
F +39 011 95 67 928
www.sirena.it
info@sirena.it

Sirena SpA can modify this catalogue at any time without prior notice. No parts of this catalogue, including text, images and logos, may be reproduced, partially reproduced or forwarded via electronic means without prior written authorization of Sirena SpA. All data reproduced in this catalogue have been edited and checked with the best possible accuracy, however Sirena SpA does not accept any liability for errors and omissions in drawings, descriptions or technical data in this catalogue.



EOS
V 1.0
01/2020
Printed in Italy